



imagination at work

User Manual

GE Digital Camera



A Series : A1255 / A1455

J Series : J1455

Preparations

Basic operation

Camera function controls

Playback

Using the Menus

Camera connectivity

Appendix

WARNING

Do not expose the camera battery pack or other accessories to rain or humidity to prevent fire hazard or electric shock.

For customers in the U.S.A.

Tested To Comply With FCC Standards FOR HOME OR OFFICE USE

FCC Statement

This device complies with part 15 of the FCC Rules. Operation is subject to the following two conditions:

(1) This device may not cause harmful interference, and (2) this device must accept any interference received, including interference that may cause undesired operation.

For customers in Europe



"CE" mark indicates that this product complies with the European requirements for safety, health, environment and customer protection. "CE" marked cameras are intended for sales in Europe.



This symbol [crossed-out wheeled bin WEEE Annex IV] indicates separate collection of waste electrical and electronic equipment in the European countries. Please do not throw the equipment into the domestic refuse. Please use the return and collection systems available in your country for the disposal of this product.

Declaration of Conformity

Model Name: A1255 / A1455 / J1455

Trade Name: GE

Responsible Party: General Imaging Co.

Address: 1411 W. 190th Street, Suite 550, Gardena, CA 90248, U.S.A.

Customer Service Telephone Number:
+1-800-730-6597

Conforms to the following Standards:

EMC: EN 55022:1998/A1:2000/A2:2003 Class B
EN 55024:1998/A1:2001/A2:2003
EN 61000-3-2:2000/A1:2001
EN 61000-3-3:1995/A1:2001

following the provision of the EMC Directive (89/336/EEC,2004/108/EEC)

SAFETY PRECAUTIONS

Camera notes:

- ❗ Do not store or use the camera in the following types of locations:
 - In the rain, very humid and dusty places.
 - In a place where the camera can be exposed directly to the sunlight or subject to high temperature, e.g. Inside a closed car in summer.
 - In a place where the camera is subject to a high magnetic field, e.g. near motors, transformers or magnets.
- ❗ Do not place the camera on a wet surface or places where dripping water or sand may come in contact with the camera, which may cause irreparable faults.
- ❗ If the camera will not be used for a long period of time, we suggest you remove the battery and the memory card from the camera and keep them in dry environment.
- ❗ If you carry the camera suddenly from a cold location to a warm place, moisture may condense inside the camera. We suggest you wait for a while before turning on the camera.
- ❗ No compensation for loss of recordings. Loss of recordings cannot be compensated for if a malfunction of your camera or recording media, etc, makes the playback of recordings not possible.

Battery notes:

- ❗ Incorrect use of the batteries may cause them to leak, become hot, ignite or burst. Always observe the precautions given below.

- Do not expose the batteries to water, and take particular care to keep the terminals dry.
- Do not heat the batteries or throw them into a fire.
- Do not attempt to deform, disassemble or modify the batteries.

- ❗ Keep the batteries out of reach of babies and small children.
- ❗ In cold locations, battery performance deteriorates and the time for which they can be used shortens markedly.

Memory card notes:

- ❗ When using a new memory card, or a memory card has been initialized by a PC, be sure to format the card with your digital camera before using it.
- ❗ To edit image data, copy the image data to the PC's hard disk first.
- ❗ Do not change or delete the folder names or file names in the memory card from your PC, as this may make it impossible to recognize or misinterpret the original folder or file in your camera.
- ❗ The photos taken by this camera are stored in the auto-generated folder in SD card. Please do not store photos that are not taken by this model of camera, as this may make it impossible to recognize the picture when the camera is in playback mode. Please do not expose the camera to harsh environments such as moisture or extreme temperatures, which may shorten the life of your camera or damage the batteries.

BEFORE YOU START

Preface

Thank you for purchasing this GE digital camera. Please read this manual carefully and keep it in a safe place for future reference.

Copyright

© Copyright 2010 General Imaging Company All rights reserved.

No part of this publication may be reproduced, transmitted, transcribed, stored in a retrieval system, or translated into any language or computer language, in any form, by any means, without the prior written permission of General Imaging Company.

Trademarks

All trademarks mentioned in this manual are used for identification purposes only and are properties of their respective owners.

Safety information

Please read the following important information carefully before using the product.

- Do not take apart or attempt to service the camera yourself.
- Do not drop or knock the camera. Improper handling may damage the product.
- Turn off the camera before inserting or removing the battery and memory card.
- Use only the type of battery that come with the camera. Using other types of batteries may damage the camera and invalidate the warranty.
- Do not touch the camera lens.
- Please not expose the camera to harsh environments such as moisture, or extreme temperatures, which may shorten the life of your camera or damage the batteries.
- Do not use or store the camera in dusty, dirty, or sandy areas, as its components may be damaged.

- Do not expose the lens to direct sunlight for extended periods.
- Download all pictures and remove the batteries from the camera if you are going to store the camera for long periods of time.
- Do not use abrasive cleansers, alcohol-based, or solvent-based cleansers to clean the camera. To clean, wipe the camera with a slightly damp soft cloth.

About this manual

This manual provides you with instructions on how to use your GE digital camera. Every effort has been made to ensure that the contents of this manual are accurate, however General Imaging Company reserves the right to make changes without notice.

Symbols used in this manual

Throughout this manual, the following symbols are used to help you locate information quickly and easily:



Indicates the useful information to know.



Indicates precautions to be taken while operating the camera.

CONTENTS

WARNING	i	Insert the Battery and SD/SDHC Card (Not included) (J Series).....	17
SAFETY PRECAUTIONS	ii	Turning On and Off	17
BEFORE YOU START	1	Using the Mode Dial	18
Preface	1	Setting Date/Time and Language	19
Copyright	1	Setting the Date and Time	19
Trademarks	1	Setting the Language	20
Safety information	1	About the LCD Screen	21
About this manual	2	BASIC OPERATION	22
Symbols used in this manual	2	Shooting in Auto Mode	22
CONTENTS	3	Using the Zoom Function	22
GETTING READY	7	Basic Functions Menu	23
Unpacking	7	Flash	23
Camera Views: A Series	8	Self-timer/Continuous Capture	24
Camera Views: J Series	10	Macro Mode	24
Charging the Battery (J Series).....	12	Exposure Compensation	24
Insert the Battery and SD/SDHC Card (Not included) (A Series)	13	Advanced Functions Menu	25
		WB (White Balance)	26

ISO	26	Manual Scene Mode (SCN)	36
Quality	27	Sport	36
Size	27	Indoor	36
Color	28	Snow	37
USING THE MODES	29	Fireworks	37
LCD Screen Display	29	Museum	37
Still Picture Mode Display	29	Night Landscape	37
Video Shooting Mode Display	31	Children	37
Playback Mode Display	32	Leaf	37
Auto Scene Mode (ASCN)	33	Sunset	37
Landscape	33	Glass	37
Portrait	33	Landscape	37
Night Portrait	34	Night Portrait	37
Backlit Portrait	34	Stabilization Mode	38
Night Landscape	34	Face Detection	39
Macro	34	Smile Detection	40
Auto	34	Blink Detection	41
Panorama	34		

PLAYBACK	42	Movie Menu	52
Viewing Photos and Videos	42	Continuous AF	53
Thumbnail View	43	Expo Metering (Exposure Metering)	54
Using Zoom on Playback (for still pictures only)	44	DIS (Only for J1455).....	54
Using the Delete Button	45	Playback Menu	55
USING THE MENUS	46	Protect	55
Still Picture Menu	46	Delete	56
AF Mode (Auto-Focus mode)	47	DPOF (Digital Print Order Format)	57
AF-assist Beam	47	Trim	58
Continuous AF	48	HDR-High Dynamic Range.....	58
Expo Metering (Exposure Metering)	48	Resize	59
Continuous Shot	49	Rotate	59
Date Imprint	50	Red-eye Reduction	60
Quick Review	50	Media Center	60
Digital Zoom	51	Slideshow	61
Slow Shutter	51	Wallpaper Settings	61
Blink Detection	52	Playing Effect (Only for J1455)	62
		Setup Menu	63

Beep	64	Setting the USB Mode	72
LCD Brightness	64	Connecting the Camera and Printer	73
Power Saver	65	Using the PictBridge Menu	74
Zone	65	Print with Date	74
Date/Time	66	Print without Date	75
Language	66	Print Index	76
File and Software	66	Print DPOF	77
File Numbering	67	Exit	77
Copy to Card (Copy internal memory to memory card)	67		
Reset Settings	68	APPENDICES	78
FW Version (Firmware version)	68	Specifications: A1255 / A1455	78
		Specifications : J1455	82
CONNECTIONS	69	Error Messages	86
Video System	69	Troubleshooting	88
Connecting to a PC	70		
Setting the USB Mode	70		
Transferring Files to your PC	70		
Connecting to a PictBridge Compatible Printer	72		

GETTING READY

Unpacking

Your package should contain the camera model you purchased along with the following items. If anything is missing or appears to be damaged, please contact your vendor.

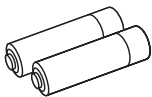

AA-size Alkaline Batteries
(A Series only)



Warranty Card

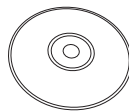

CD-ROM



Wrist Strap

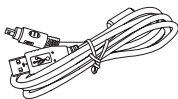

USB Cable



Rechargeable Lithium-ion
battery (Except A Series)

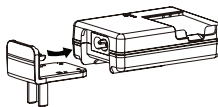

Battery charger (Except A Series)

Camera Views: A Series

Front View

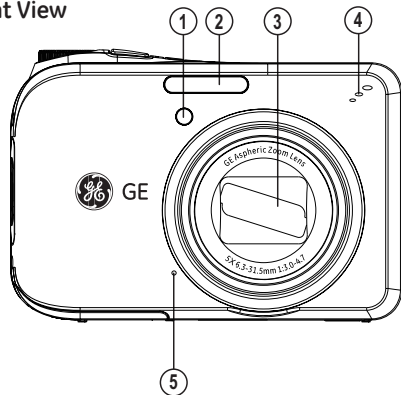

Back View

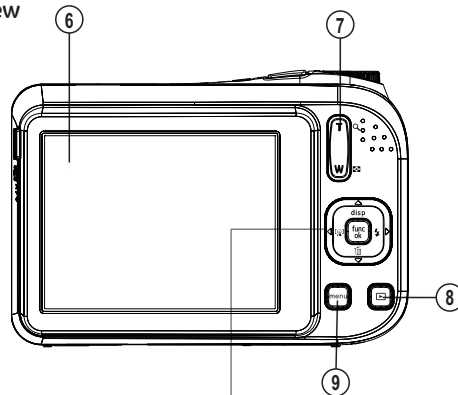

Right View

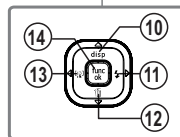
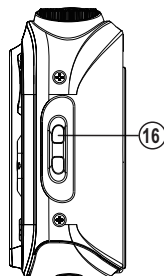

Top View

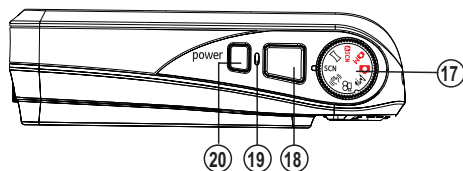

Bottom View

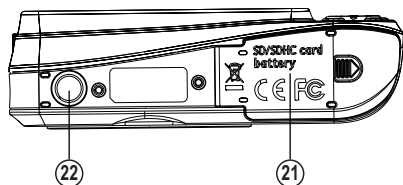

Left View

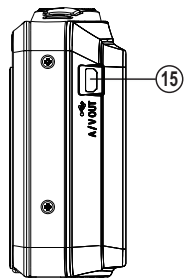

1	AF Assist/Timer Indicator	12	Delete Button/Down Button
2	Flash Lamp	13	Face Detection/Left button
3	Lens	14	Function/OK Button
4	Speaker	15	USB/AV Port
5	Microphone	16	Wrist Strap
6	LCD Screen	17	Mode Dial
7	Zoom Button	18	Shutter Button
8	Playback Button	19	Status Indicator
9	Menu Button	20	Power Button
10	Disp/Up Button	21	Card Slot/Battery Compartment
11	Flash Mode/Right Button	22	Tripod Socket

Camera Views: J Series

Front View

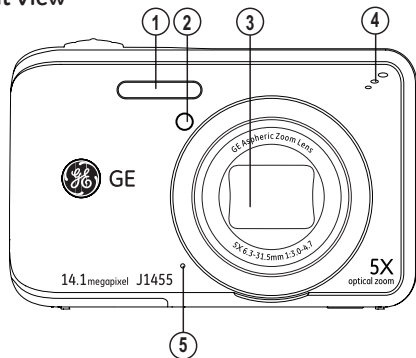

Back View

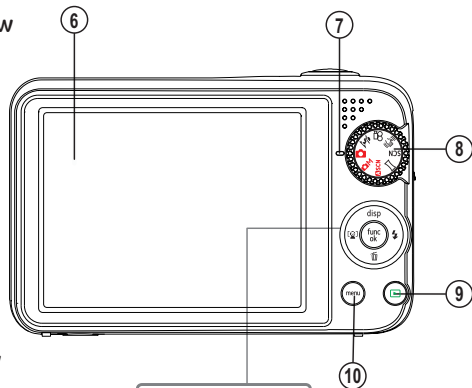

Right View

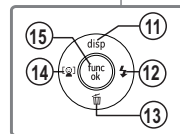
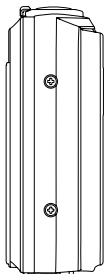

Top View

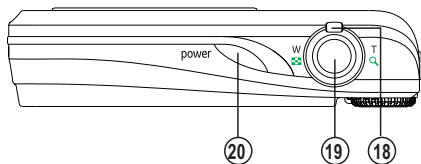

Bottom View

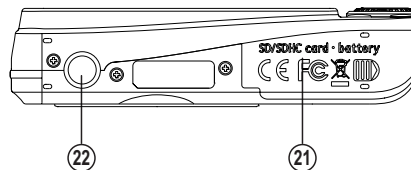

Left View

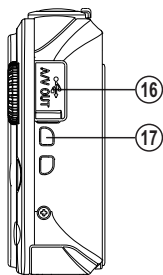



1	Flash Lamp	12	Flash Mode/Right Button
2	AF Assist/Timer Indicator	13	Delete Button/Down Button
3	Lens	14	Face Detection/Left button
4	Speaker	15	Function/OK Button
5	Microphone	16	USB/AV Port
6	LCD Screen	17	Wrist Strap
7	Status Indicator	18	Zoom Wheel
8	Mode Dial	19	Shutter Button
9	Playback Button	20	Power Button
10	Menu Button	21	Card Slot/Battery Compartment
11	Disp/Up Button	22	Tripod Socket

Charging the Battery (J Series)

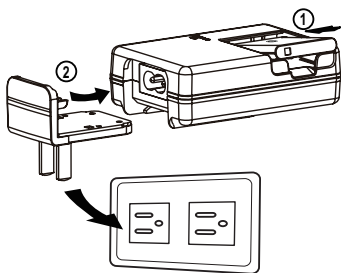
1. Place the battery into the charger as shown.
2. Plug the one end of the connecting cable (plug adapter) into the charger base (the plug adapter may vary in different countries, please subject to the actual object).
3. Plug the other end of the connecting cable into a the wall outlet.



 Leave the battery to charge until the charger light turns green. (To maximize battery life, the first charge should be at least 4 hours)

 The charger is for indoor use only.

Insert the Battery and SD/SDHC Card (Not included) (A Series)

1. Open the battery compartment.

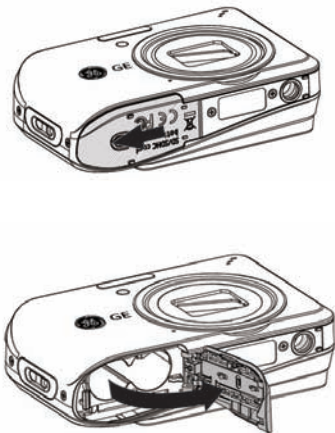

2. Insert the enclosed batteries into the battery slot in the correct direction.

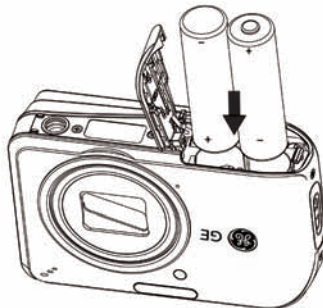

3. Insert an SD/SDHC card (not included) into the memory card slot as shown.

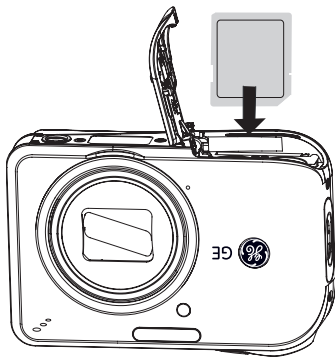

4. Close the battery compartment.

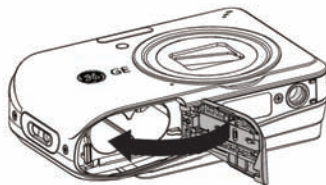

Insert the Battery and SD/SDHC Card (Not included) (J Series)

1. Open the battery compartment.

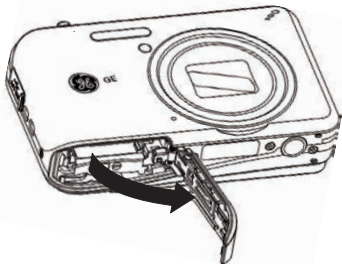
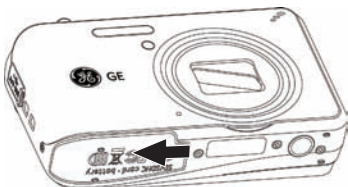

2. Insert the battery while observing the correct polarity. Use the side of battery to press down the stopper as shown, allowing the battery lock into place properly.

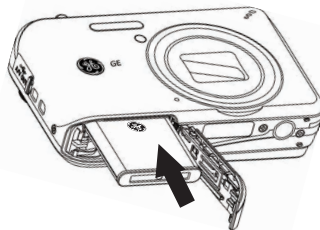
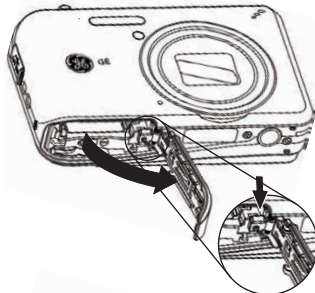

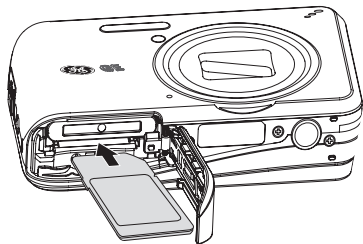

3. Insert an SD/SDHC card (not included) into the memory card slot as shown.

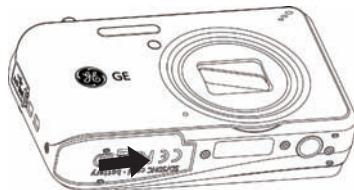
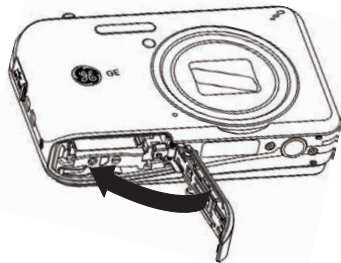

4. Close the battery compartment.



 Optional SD/SDHC cards are not included. The use of 64 MB to 16 GB memory cards from recognized manufacturers such as SanDisk, Panasonic and Toshiba is recommended for reliable data storage.

 To remove the SD/SDHC card, open the battery compartment and gently push the card to release it. Pull the card out carefully.

 Throughout the rest of the manual, the following illustrations show the A Series model as an example. The J Series models operate similarly.

Turning On and Off



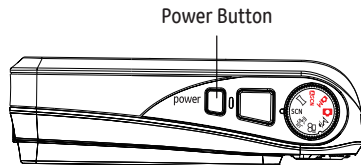



Press the Power button to turn the camera on. To turn off the camera, press the Power button again.



When the camera is turned on, it will be at the same shooting mode based on the last use. You can turn the Mode Dial on the top to select. When using the camera for the first-time, the language setting page will appear. Please see page 19 or the Quick Start Guide in the package for details.

Using the Mode Dial

The GE camera provides a convenient mode dial that allows you to switch between different modes with ease. All the available modes are listed as follows:

Mode Name	Icon	Description
Auto		Switch to take still pictures in automatic mode.
Manual		Switch to take still pictures in manual mode, where many camera settings can be configured. (Recommended for advanced users only)
Panorama		Switch to capture a sequence of shots and stitch them together into a panoramic photo.
Stabilization		Switch to take still pictures by reducing the blurs caused by hand shake, under low luminance, or slow shutter speed.
Scene	SCN	Switch to take still pictures in 12 different scene types by your choice.
Movie		Switch to record videos.
Auto Scene		Switch to have the camera automatically select the best scene type for still pictures.
Portrait Mode		Switch to take portrait pictures under normal condition.

Setting Date/Time and Language

To set the language, date, and time, go to the following setup options in the **Setup** menu.

- Date / Time
- Language

To access the **Setup** menu, do the following:

1. Press **Power** to turn the camera on.
2. Press the **menu** button, switch among the setting menus by using the **Left/Right** button to select the corresponding basic setting menu.
3. Press the **func ok** button to confirm the setting.

Setting the Date and Time

1. Use the **Up/Down** button to select **Date/Time**. Then press the **Right** button to enter the setting.
2. Press the **Left/Right** to highlight each field and use the **Up/Down** to adjust the value.
3. Press the **func ok** button to confirm the setting.

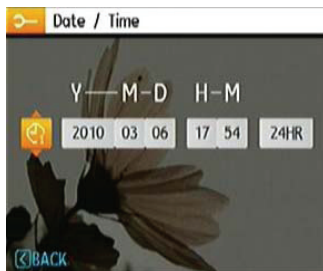
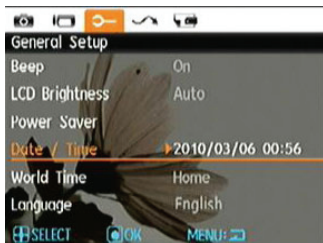

Setting the Language

1. Use the Up/Down button to go to the Language. Then press the Right button to enter the setting.
2. Use the Left/Right buttons to select the desired language.
3. Press the $\begin{matrix} \text{func} \\ \text{ok} \end{matrix}$ button to confirm the setting.



The Date/Time and Language setup will automatically appear when the camera is turned on the first time.



About the LCD Screen

When you turn the camera on, various icons are shown on the LCD screen to indicate the current camera settings and status. To learn more about the displayed icons, see “LCD Screen display” on page 29.

LCD Screen notes:

Extremely high-precision technology had been used to manufacture the LCD screen so that most of the pixels are operational for use. However, there may be some minute points (black, white, red, blue or green) that constantly appear on the LCD screen. These points are normal in the manufacturing process and the recording is not affected in any way.



Avoid exposing the LCD screen to water; please remove any moisture on the LCD screen with dry and soft cleaning cloth.



If the LCD monitor is damaged, take particular care with the liquid crystal in the monitor. If any of the following situations arise, take the recommended immediate action indicated below:

- If liquid crystal comes in contact with your skin, wipe the area with a cloth and then wash thoroughly with soap and running water.
- If liquid crystal gets into your eye, flush the affected eye with clean water for at least 15 minutes and then seek medical assistance.
- If liquid crystal is swallowed, flush your mouth thoroughly with water. Drink large quantities of water and induce vomiting. Then seek medical assistance immediately.

BASIC OPERATION

Shooting in Auto Mode

Auto mode is the easiest mode to take photos. While operating in this mode, the camera automatically optimizes your photos for best results.

To start shooting, do the following:

1. Press **Power** to turn the camera on.
2. Switch the Mode dial into **Auto** mode ().
3. Compose your picture on the LCD screen and press the Shutter button halfway to focus on the subject.
4. The LCD screen will show green focus frame after the subject is in focus.
5. Press **Shutter** fully to capture the image.

Using the Zoom Function

Your camera is built with two zoom functions: Optical Zoom and Digital Zoom. When shooting photo, you can zoom in or zoom out the shot subject by using Zoom button/zoom lever on the camera.

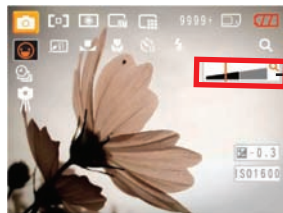
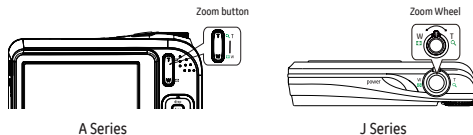

Zoom indicator (See "Digital Zoom" on page 51)

When the Optical Zoom is at the critical point, release the Zoom button/zoom lever and then adjust it again, and the camera will switch between Optical Zoom and Digital Zoom automatically. After adjustment, the zoom display shaft will be hidden, and it displays **TQ** only to show it is in zoom status currently.

Basic Functions Menu

The Basic Function Menus of the camera include Flash, Self-timer, Macro Capture, and Exposure Compensation. The suitable function setting can let you shoot better photos.

Set the basic functions as per the following steps:

1. Pull up the Basic Function Menus by pressing Right/Flash button.





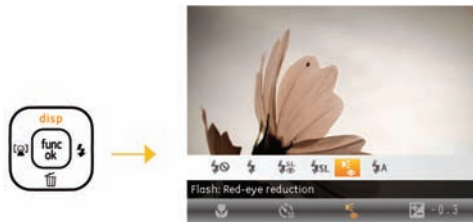



2. Select the basic function for setting by pressing Left/Right button.
3. Enter the selection by pressing Up button.







4. Select a setting by Left/Right button, press **func ok** button to confirm the setting and exit menus, or return to the Basic Functions Menu by pressing Down button.

Flash



-  Auto Flash
Camera flash goes off automatically based on existing light conditions.
-  Red-eye Reduction
The camera exposes a brief flash before the picture is taken to reduce red-eye effects.
-  Forced Flash
Flash always goes off.

-  Forced Off
Flash is turned off.
-  Slow Synchro
This allows you to take pictures of people at night that clearly show both your subjects and the night time backdrop.
-  Red-Eye + Slow Synchro
Using this mode for slow synchro shots with red-eye reduction.

Self-timer/Continuous Capture

-  2-second Timer
A single picture is shot 2 seconds after the Shutter button is pressed.
-  10-second Timer
A single picture is shot 10 seconds after the Shutter button is pressed.
-  Continuous Shot
Pictures are shot continuously when the Shutter button is pressed down based on the Continuous Shot settings in the menu. (See "Continuous Shot" on page 49).
-  Self-timer Off
Disable the self-timer.

Macro Mode

-  Macro
Select this to focus on subjects 5cm from the lens.
-  Macro Off
Select this option to disable Macro.

Exposure Compensation

The exposure compensation allows you to adjust the light exposure value and shoot the best photo.



The adjustable range of exposure value is from EV -2.0 to EV+2.0.

Advanced Functions Menu

The Advanced Functions Menu of the camera include Image Size, Image Quality, White Balance, Image Color and ISO etc. The suitable function setting can let you shoot better photos and videos.

Set the advanced functions as per the following steps:

1. Pull up the Advanced Function Menus by pressing **func ok** button.



2. Select the advanced function for setting by pressing Left/Right button.
3. Enter the selection by pressing Up button.









4. Select a setting by Left/Right button, press **func ok** button to confirm the setting and exit menus, or return to the Advanced Functions Menu by pressing Down button.

WB (White Balance)

The White Balance allows you to adjust the color temperature under different light source to ensure faithful color reproduction. (The WB setting is only available when the camera is in the **M** Manual mode).



The options of White Balance include:

-  Auto
-  Daylight
-  Cloudy
-  Fluorescent
-  Fluorescent CWF
-  Incandescent
-  Manual (Press the Shutter button to detect WB)

ISO

The ISO function allows you to set the sensitivity of the camera sensor based on the brightness of the scene. To improve the performance in darker environments, a higher ISO value is required. On the other hand, a lower ISO value is needed when in bright conditions. (The ISO setting is only available when the camera is in the **M** Manual mode).

Pictures at higher ISO will naturally have more noise than those at lower ISO.



The options of ISO include automatic, 80, 100, 200, 400, 800 and 1600.



The available ISO values vary on different camera models.

Quality

The quality setting adjusts the compression ratio of the images. Higher quality settings give better photos, but will take up more memory space.



Size

The size setting refers to the image resolution in pixels. A higher image resolution allows you to print that image in larger sizes without degrading the image quality.



The picture quality of image has totally three options:

-  : Best
-  : Fine
-  : Normal



The bigger the number of recorded pixels is, the better the image quality becomes. As the number of recorded pixels becomes smaller, you will be able to record more frames on a memory card.

Color

The color setting allows you to add artistic effects directly when taking pictures. You can try different color tones to alter the mood of your pictures. (The Color setting is only available when the camera is in the **M** Manual mode).



The color options include:

- **OFF** Auto
- **BW** Black & White
- **SE** Sepia
- **VI** Vivid

USING THE MODES





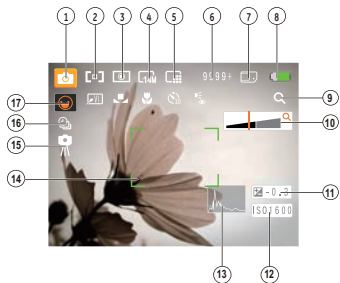

LCD Screen Display

Still Picture Mode Display

Mode:    SCN   





1 Shooting Mode Icons

-  Auto
-  Manual
-  Auto Scene
-  Scene
-  Stabilization
-  Portrait Mode
-  Panorama

2 AF



-  Single-AF
-  Multi-AF

3 Expo Metering

-  Spot
-  Center
-  AiAE

4 Image Size







5 Image Quality

- 6 Remaining number of pictures
- 7 Memory card/built-in memory
- 8 Battery Status
- 9 WT Ratio (Displayed only when zoom is activated)
- 10 Zoom
- 11 Exposure
- 12 ISO Value (Adjustable only in  Manual Mode)
- 13 Histogram
- 14 Focus Frame
- 15 Slow Shutter Warning
- 16 Continuous Shot
- 17 Face Detection
- 18 Picture Color (Adjustable only in  Manual Mode)
- 19 White Balance (Adjustable only in  Manual Mode)
- 20 Macro Mode
- 21 Self-timer

 2-sec

 10-sec





22 Flash Mode

-  Auto
-  Red-eye Reduction
-  Forced Flash
-  Forced Off
-  Slow Synchro
-  Red-Eye + Slow Synchro

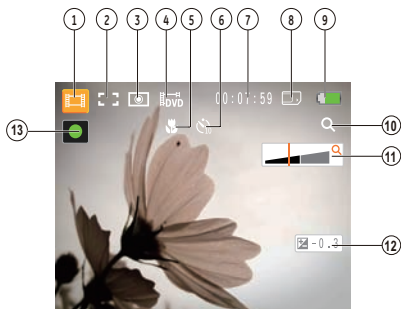
Video Shooting Mode Display

Mode : 



- 1 Video Mode icon
- 2 AF
 Single-AF
 Multi-AF
- 3 Metering
 Spot
 Center
 AiAE

- 4 Video Quality
- 5 Focus Frame
- 6 Self-timer

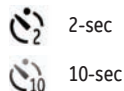



- 7 Remaining Time for Video Recording
- 8 Memory Card/Built-in Memory
- 9 Battery Status
- 10 WT Ratio (Displayed only when zoom is activated)
- 11 Zoom
- 12 Exposure
- 13 Recording Status Icon



Recording standby



Recording

-  For optimal video shooting, it is recommended that the SD card be used. If you shoot videos with the limited built-in memory as a result of short video recording, there may be picture jitter and noise.
-  During video shooting, the optical zoom is fixed but the highest 1.5x digital zoom is still available.

Playback mode display

Mode: ▶

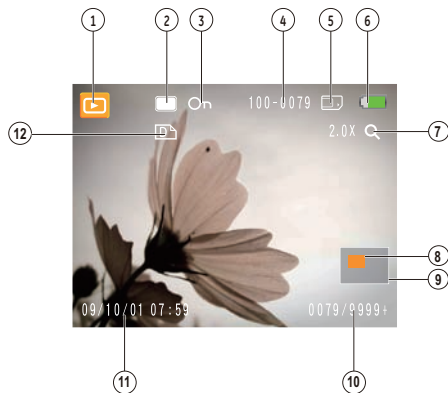

1. Play Mode icon
2. Picture File
3. File protection
4. Picture Number
5. Memory Card/Built-in Memory
6. Battery Status
7. Image Zoom
8. The current display area
9. Affecting regional
10. Memory Space (this picture/Total number of pictures)
11. Recording Date and Time
12. DPOF file

Auto Scene Mode (ASCN)

In the "ASCN" mode, different recording conditions are detected intelligently and the most suitable settings will be automatically selected. With "ASCN" you can always take good pictures easily.

To use "ASCN":

1. Turn the mode dial to "ASCN", LCD display showing the following diagram.

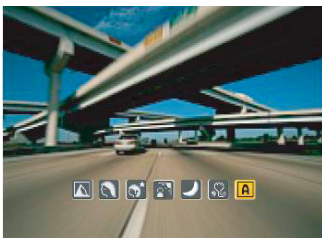

2. Hold the camera steadily and aim at the subject. The optimum scene mode will be identified automatically.
3. Press the Shutter button halfway down to focus.
4. Press the Shutter button all the way down to take the picture.

Icon	Mode name	Icon	Mode name
	Landscape Mode		Night Landscape Mode
	Portrait Mode		Macro Mode
	Night Portrait		Auto Mode
	Backlit Portrait		

Landscape Mode

For landscapes, ASCN will automatically adjust the exposure to match the background.

Portrait Mode

For portraits, ASCN will automatically adjust the exposure and skin tones to give clear pictures.

Night Portrait

When you shoot portraits at night, or in low light conditions, ASCN will automatically adjust the exposure for people and night scenes.

Backlit Portrait

When the sun or any other light source is behind you, ASCN will automatically adjust the foreground exposure to produce good pictures.

Night Landscape Mode

For night scenes, ASCN will automatically increase the ISO value to compensate for low light.

Macro Mode

To capture object detail for close-ups, ASCN will automatically adjust the focus.

Auto Mode

The camera will automatically adjust the exposure and focus to ensure good pictures.

Panorama

Panorama Mode allows you to create a panoramic picture. The camera will automatically compose a panoramic picture using the individual shots that you take.

Follow these steps to create a panoramic picture:

1. Turn the mode dial to the Panorama Mode. Then enter the Photo Setup to Select either Auto Stitching or Manual Stitching.
2. Use the **Left/Right** buttons to specify the direction of picture taking, and then in 2 seconds the panoramic sequence will commence automatically.
3. Compose the first view of the panoramic picture on the LCD screen and press the Shutter button to capture.
4. Following are different steps for the Auto Mode and Manual Mode selected for the Panorama Mode in the Photo Setup.

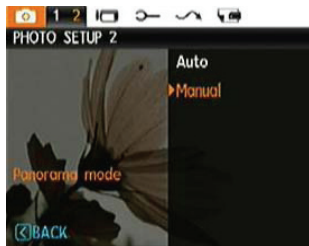

When Using Auto Mode:

After the first shot is taken, two target icons will appear on the left and right side of the LCD screen. Pan the camera and the circle icon on the screen will move towards the square frame icon. When the circle icon and square frame become green once they overlap, the camera will capture the next picture automatically. Repeat the same step for the third picture to finish the stitching.







When Using Manual Mode:

After the first shot is taken, the semi-transparent image of the first shot will appear at the edge of the screen. You can use this image to compose your picture before you press the Shutter button to capture and finish manual stitching.



5. The camera will then stitch the pictures into a panorama automatically.
6. Press the playback button to enter Playback mode and review the panorama result.

-  After taking a Panoramic picture press the func/ok button to save and exit or press the Delete button to cancel and exit.
-  Flash Mode, Self-timer, Macro Mode, and Exposure Compensation are disabled on Panorama Mode.
-  Pictures cannot be deleted, nor the zoom adjusted until the series is finalized.
-  Panorama Mode can stitch 2 or 3 maximum pictures.

Manual Scene Mode (SCN)

In **Manual Scene** mode, you can select from a total of 12 scene types to match your needs. You just need to select the right scene for the occasion and the camera will automatically adjust to the optimal settings for you. To enter the Scene Mode, turn the mode dial to **Manual Scene** mode. The Scene Mode palette appears.

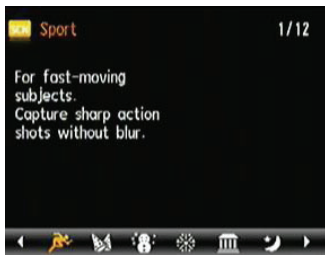

Select a scene using the Left/Right button and press the **func** **ok** button.

Icon	Mode Name	Icon	Mode Name
	Sport		Indoor
	Snow		Fireworks
	Museum		Night Landscape
	Children		Leaf
	Sunset		Glass
	Landscape		Night Portrait

Sport

For shooting fast-moving objects. Bring lively pictures to life.

Indoor

For shooting people indoors. Clearly show background and atmosphere.

Snow

Suitable for snowy landscape. Camera automatically adjusts and corrects exposure value (EV).

Fireworks

For shooting at night and fireworks. Shutterspeed is slower than normal. (Use of tripod is recommended)

Museum

For shooting in museums or places where flash is not allowed.

Night landscape

For shooting night scenes. Use of tripod is recommended.

Children

Suitable for photographing children and pets. The flash shuts off automatically in order not to disturb the subject being photographed.

Leaf

For shooting plants. Vivid reproduction of green.

Sunset

For shooting sunsets. Vivid reproduction of red and yellow.

Glass

Suitable for photographing objects behind glass or window.

Landscape

For shooting landscapes. Vivid reproduction of green and blue.

Night portrait

For shooting portraits with night scenes as background.





1. After selecting the scene type, press the **func ok** button to activate.
2. To select a different scene type, press the **func ok** button to enter the main function menu. Then press it again to return to the to Scene selection menu.

The main function menu also allows you to adjust the image quality and image size. Please refer to the "**Advanced Functions Menu**" section on page 25 for detailed instructions.

Stabilization Mode

This mode can help reduce photo blur caused by hand shake, low light and slow shutter speed



-  Use stabilization mode in dark environments or when in slow shutter speed
-  Shooting in a windy or unstable environment (such as a moving vehicle) may cause blurred images.

Face Detection

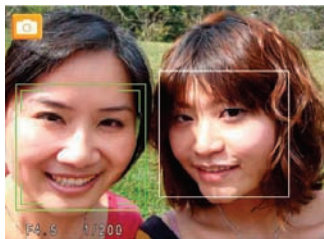
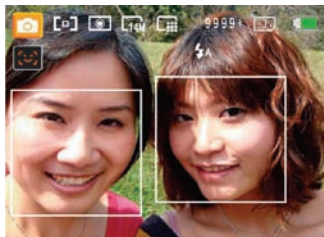

The Face Detection mode will detect and focus on faces of persons during picture shooting so that the faces will be clearer.

1. In Shooting Mode, press the Left/Face Detection button to turn on the Face Detection and an icon () appears on the LCD.
2. Hold the camera securely, and point the camera towards the subject to start the face detection process. When the camera detects a face, a white rectangular frame will be drawn around the face. (Note: For best results, the face of the subject should be relatively large on the LCD screen, and the subject should be facing the camera as front on as possible.)
3. Press **Shutter** halfway to focus on the subject.
4. Press **Shutter** fully to capture the image.
5. Press the Left/Face Detection button to turn off Face Detection.



Smile Detection

With the camera's new "Smile Detection" feature, which automatically detects and captures a person smiling, you'll never miss a smile.

1. In Shooting Mode, press the Left/Face Detection button to turn on Smile Detection and an icon (😊) appears on the LCD.
 2. Point the camera at the subject until the subject's face is detected and bracketed by a square box. Press the Shutter button all the way down and release the Shutter button. The camera will now 'wait' for the subject to smile.
 3. When the subject smiles, the camera will automatically release the shutter and capture the photo.
 4. To disable Smile Detection function, please press Left or Shutter button.
-  A face must be detected by the camera in order for smile detection to function correctly.
-  For optimal detection results, the subject should be framed to occupy most of the screen space.

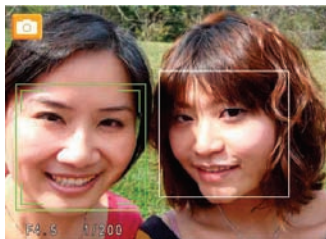

Blink Detection

The Blink Detection feature is on by default, and after taking each photo, a warning message will pop up if a blink had been detected in the photo.

1. In any Still Shooting modes, press the menu button to enter the photo menu.
2. Switch between different Photo Setup menus and Camera Setup menus using the Left/Right button, and select the "Blink Detection" setting using the Up/Down button.
3. Use the Right navigation buttons to enter the submenu, and select "On" option.
4. Press the func / ok button to confirm the setting and exit the menu.
5. The "Blink detection" indicator appears on the LCD.
6. Press the Shutter button fully to capture the image. If someone has blinked, the camera will show blink detection warning message right after.



A face must be detected by the camera in order for smile detection to function correctly.



For optimal detection results, the subject should be framed to occupy most of the screen space.



Viewing Photos and Videos

To view the captured photos and video clips on the LCD screen:

1. Press **[▶]** button to go to the **Playback** mode. The last recorded photo or video clip is displayed.
2. Use the **Left/Right** navigation buttons to scroll through the photos or video clips stored in the internal memory or memory card.
3. To play a selected video clip, press the **func**/**ok** button to enter the movie playback mode.

During video playback, the operating instructions will appear on the screen. Press the Left/Right button, and press the **func**/**ok** button for confirmation.

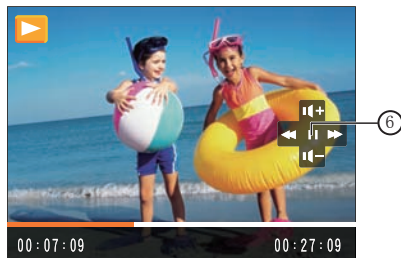
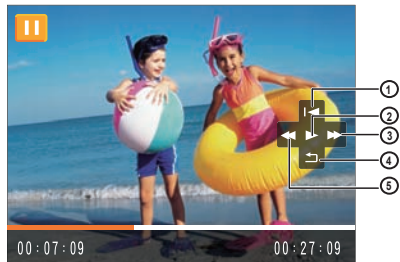

The operating instruction icons are as follows.

- | | | | |
|---|--------------|---|--------|
| 1 | First Frame | 4 | Back |
| 2 | Play | 5 | Rewind |
| 3 | Fast Forward | 6 | Pause |

During video playback, you can press the Up/Down button to adjust the volume.

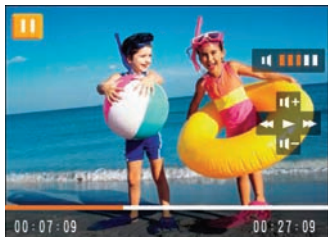

Thumbnail View

In Playing Mode, adjust the Zoom button/zoom lever to the side  W, so as to display thumbnail of photo or video in the screen.



1. Display thumbnail with 2x2, 3x3 and 4x4 by switching the Zoom button/zoom lever.
2. Use **Up/Down/Left/Right** to select a photo or video clip to view.

 If the  indicator appears on the LCD, then a movie file is currently being displayed.

 Press the **func**
ok button to restore a preview icon to its original image size.

Using Zoom Playback (for still pictures only)

When playing photo, you can also use Zoom button/zoom lever to zoom in it 8 times.

1. Press  button to go to the **Playback** mode.
2. Use the **Left/Right** navigation buttons to select a photo to magnify.
3. Adjust the Zoom button/zoom lever to the side  to zoom in the photo.
4. Use the Zoom buttons to zoom in and out. The zoom indication and the frame of the whole photo shall display on the screen.



5. Use the navigation buttons to pan across the image.
6. Press the  button to return the image to its original scale.



Movie images cannot be magnified.

Using the Delete Button

In Playback Mode, you can press the Down/Delete button to delete pictures or videos.

To delete pictures or videos:

1. Press  button to go to the Playback Mode.
2. Select a picture or video clip you want to delete with the Left/Right button.
3. Press the Down/Delete button and the delete screen appears.

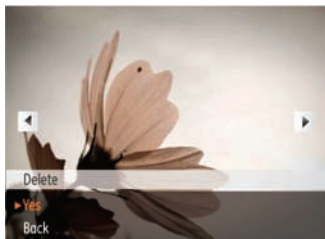

4. Select Yes or Back with Up/Down button and press the ^{func}ok button for confirmation.



Erased photos/video clips cannot be recovered.



Please refer to page 56 for instructions on the Delete Menu options.

USING THE MENUS

Still Menu

Mode:     

In any of the above Still Picture Modes, press the menu button to go to the Still Picture menu.

To adjust each setting:

1. In the Still Picture menu, switch between different Photo Setup or Camera Setup pages using the Left/Right button, to select the page with the function you want to adjust and press the Down button.



2. Press the Up/Down buttons to select the function.
3. Press the Right button to go to the submenu.

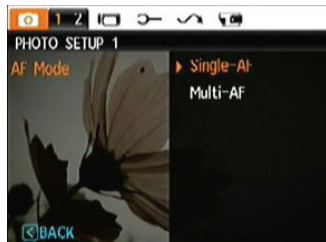

4. Press Up/Down button to select an option or press the Left or menu button to return to the menu.
5. Press the func button for confirmation and exit the menu.



After selecting a function, you can press the Up button to return to the Still Picture menu for other Photo Setup or Camera Setup pages. Or you can press the Down button several times to move to the next setup menu page.

Refer to the following pages for more details about each setting.

AF Mode (Auto-Focus mode)

Use this setting to control the auto-focus mechanism while taking pictures.

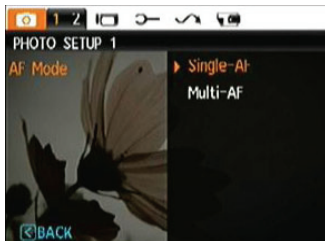

Two options are available:

- **Single-AF:** The focus frame appears on the center of the LCD screen to focus on the subject.
- **Multi-AF:** The camera automatically focuses the subject in a wide area to find the focus point.

AF-assist Beam

This option can turn on or turn off AF assist lamp. It can strengthen focusing to turn on the AF assist lamp in dark conditions.

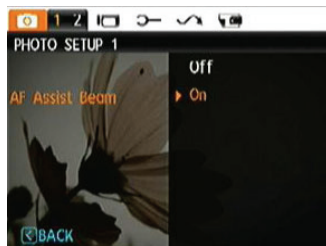

Continuous AF

After Continuous AF is turned on, the camera will adjust focus automatically in response to any camera or subject movement.

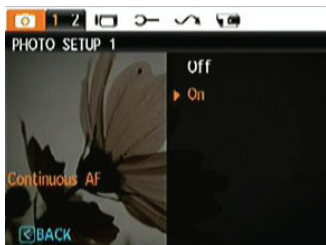

Expo Metering (Exposure Metering)

Use this setting to select an area for the exposure to be obtained.

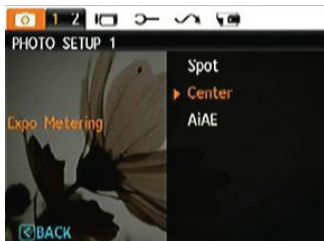

Three options are available:

- Spot
- Center-Weight
- AiAE (Artificial Intelligence AE)

Continuous Shot

Use this setting to perform continuous shooting. Once in this mode, you must continuously hold down the Shutter button to use this function.



Four options are available:

- **Continuous shooting:** Press and hold the shutter to shoot continuously until you release the shutter or when the memory card has run out of space.
- **3 shot:** Capture up to 3 consecutive pictures.
- **3 shots (Last):** Capture pictures continuously until the Shutter button is released but only the last 3 shots are recorded.
- **Time-Lapse:** Automatically capture pictures in a pre-defined interval.

 The flash is designed not to work in this mode in order to enable quick succession of shots.

 Continuous Shot can only be selected in Self-timer Mode.

Date Imprint

Include a Date/Time stamp in the photo image.

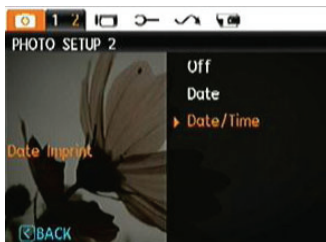

- Off
- Date
- Date and Time

Quick Review

This setting refers to the quick photo review immediately after taking a picture. The picture stays on the LCD screen for an adjustable period of time.

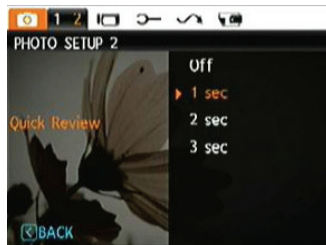

Four options are available:

- Off
- 1 sec
- 2 sec
- 3 sec

Digital Zoom

Use this setting to enable or disable the digital zoom function. When disabled, only the optical zoom is enabled.

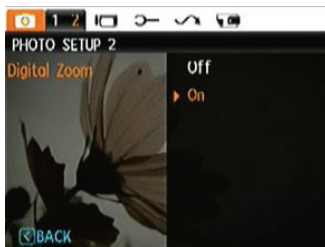

Digital Zoom indicator:

- Off: gray color.
- On: reddish color.

Slow Shutter

In Slow shutter mode, the shutter will remain open as long as the Shutter button is pressed. This gives you complete control over the duration of exposure. (The slow shutter mode is available only in **M** manual mode.)

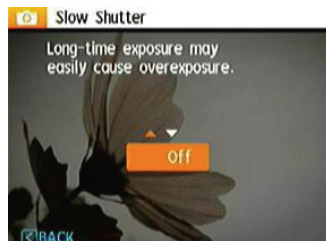

- **Manual** : To set a long exposure time between 2~30 sec.



The use of tripod is recommended for prolonged exposure.

Blink Detection

The Blink Detection feature is on by default, and after taking each photo, a warning message will pop up if a blink was detected in the photo.

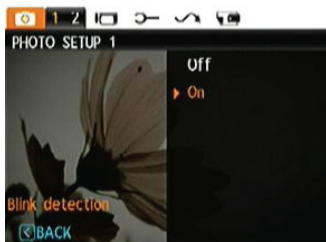

- Off
- On

Movie Menu

Mode: 

In the Movie Mode, press the menu button to go to the corresponding Movie menu.

To configure each setting:

1. In the Movie menu, switch between the Movie Setup or different Camera Setup pages using the Left/Right button, select the page with the function you want to adjust and press the Down button.

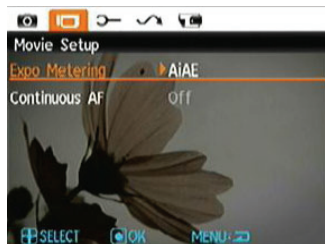

2. Press the Up/Down button to select the function and press the Right button to go to the submenu.

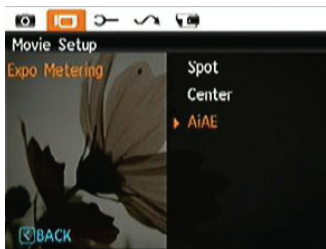

3. Press the Up/Down button to select an option or the Left or menu button to return to the menu.
4. Press the func
 ok button for confirmation and exit the menu.

Refer to the following pages for more details about each setting.

Continuous AF

After Continuous AF is turned on, the camera will adjust focus automatically in response to any camera or subject movement.

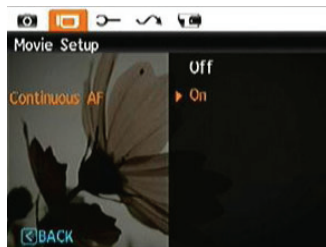

Expo Metering (Exposure Metering)

Set metering mode for various lighting conditions.

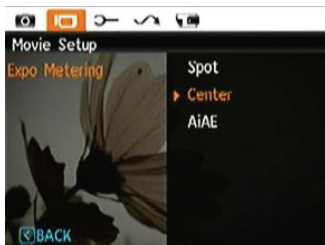

DIS (Only for J1455)

Using this function can ensure the maximum stability of the screen when recording video.

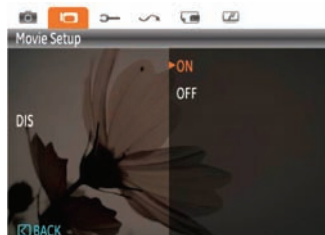

Three options are available:

- Spot
- Center
- AiAE (Artificial Intelligence AE)

Playback Menu

Mode : 

In Playback mode, press the **menu** button to enter the **Playback** menu.

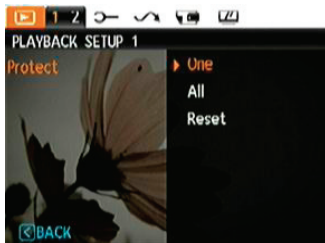

Please refer to the following sections for detailed instructions on the various menu options.

Protect

To prevent any pictures or videos from being accidentally erased, use this setting to lock one or all of the files.

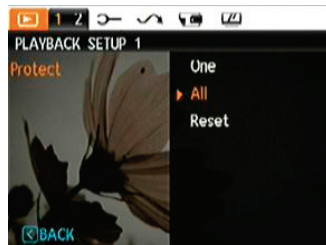

To protect/unprotect a picture or video:

1. Press  button and find the picture or video you want to protect by using Left/Right button. Once it is displayed on the screen, go to the Playback menu, select Protect settings and press the Up/Down button to make your selection.
2. Press the Up/Down button to select the protection setting option and press the Right button to go to the submenu.

- Use the **Up/Down** navigation buttons to select **One** to protect this picture/video, or select **All** to protect all pictures/videos in the internal memory or memory card. Then press the **Right** navigation button to enter the submenu.
- Press the **func ok** button to select **Yes** to lock. For locked picture/video, use **Unlock** option to unlock it.
- A key () icon will appear on the top of the screen to indicate that the picture/video is protected.
- Select **Reset** on the Protection setting to cancel protection for all files that have been placed in the protected mode.

Delete

There are two ways to delete files.

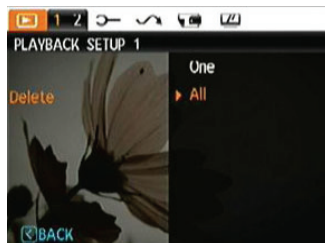

• Delete One:

- On the **Delete** setting, select **Delete One** and then press the **Right** button.
- Using the **Left/Right** buttons, locate the photo or movie file to be deleted. Select **Yes** (to delete file) or **No** (to return to the previous menu) using the **Up/Down** buttons, then press the **func ok** button to confirm.

- **Delete All:**

1. On the Delete setting, select **Delete All** and then press the **Right** button.
2. Using the **Left/Right** buttons, select **Yes** (to delete all files) or **No** (to cancel and return to the previous menu).



The “🔒” indicator means a file is protected. File protection must be removed first before a file can be deleted.



Deleting files will cause DPOF settings to be reset.

DPOF (Digital Print Order Format)

DPOF allows you to record your selection of pictures that you would like to print, and will save your selection in the memory card, so that you can simply hand your memory card to a photo kiosk without having to tell them in person which photos you would like to print.

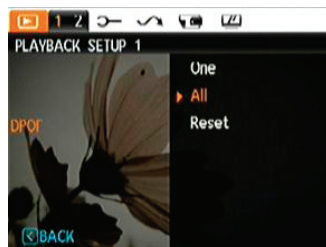

Trim

The Trim setting allows you select an area of the photo you want to keep and then save it as a new photo.

To trim a picture:

1. Select the **Trim** setting from the  menu.
2. Using the **Left/Right** buttons, locate the photo that you want to crop and have it displayed on the LCD.
3. Use the zoom buttons and navigation buttons to adjust the trimming box to fit the location and size of the new picture.

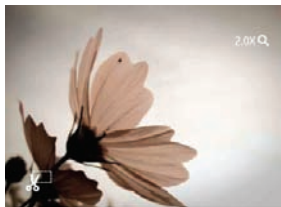

4. Press the **Shutter** button to save what you see on the LCD screen as a new picture, or the **menu** button to cancel and return to the **Playback** menu.



The image can not be clipped again when it is clipped to 640X480.

HDR-High Dynamic Range

With the HDR function, pictures that may be overexposed may be corrected to optimize the highlights and lowlights captured to more accurately represent the real scene.

1. Select HDR setting in  menu as described previously.
2. Press Left and Right button to find picture you want to optimize and then select Confirm to perform HDR optimization or select Return to go back to Playback menu.



3. After using HDR function, the image will be saved as a new file, and the original file is still stored in the memory.

Resize

This setting allows you to resize a picture to a specified resolution, and saves it as a new picture.

1. Select the **Resize** setting from the **Playback** menu as described previously.



2. Use the **Left/Right** navigation buttons to select a picture to resize.
3. Use the **Up/Down** navigation buttons to select a resolution (1024X768 or 640X480) to resize the image or **Back** to cancel and return to the **Playback** menu.
4. Press the **func**/**ok** button to confirm the setting.



Resizing an image creates a new file that contains the image in the size you select. The file with the original image also remains in memory.

Rotate

You can use this setting to change the picture orientation of the picture.

1. Select the **Rotate** setting from the **Playback** menu as described previously.
2. Use the **Left/Right** navigation buttons to select a picture to rotate.
3. Use the **Up/Down** navigation buttons to select the direction for rotation or **Back** to cancel and return to the **Playback** menu.



4. Press the **func**/**ok** button to confirm the setting.

Red-eye Reduction

Use this setting to remove red-eyes in your photos.

1. Select the **Red-eye Reduction** in **Playback** menu as described previously.
2. Use the **Left/Right** button to select the picture from which the red-eye needs to be removed.
3. Use the **Up/Down** navigation buttons to select **Yes** to fix the selected image or **Back** to cancel and return to the **Playback** menu.

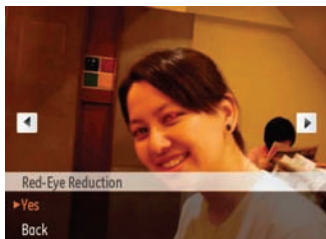

4. Press the **func**/**ok** button to confirm the setting.



For best results, the face of the subject should be relatively large on the LCD screen, the subject should be facing the camera as front on as possible, and the red eyes should be as large as possible.

Media Center

Mode: 

Press **menu** button in **Playback** mode to enter **Media Center** menu.

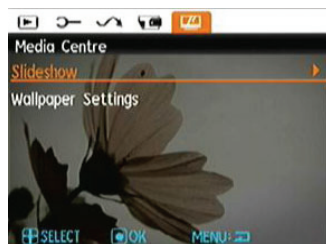

Refer to the following sections for details of every setting.

Slideshow

This setting allows you to view all the stored pictures as a slideshow.

1. Select the slideshow menu, press the right button to enter the options menu.
2. Use the Up/Down navigation buttons to select Effect, Interval time, or Repeat and use the Left / Right navigation buttons to adjust the setting.

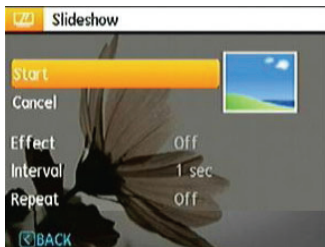

3. Use the Up/Down navigation buttons to select Start to run the slideshow or Cancel to return to the Playback menu.
4. Press the func_{ok} button to confirm the setting.

Wallpaper Settings

Use this setting to select your favorite picture to use as a background on the LCD screen.

1. Use this setting to select your favorite picture to use as a background on the LCD screen.
2. Press Up/Down button to select wallpaper settings, welcome screen setting or default, and press Right button to adjust setting value.

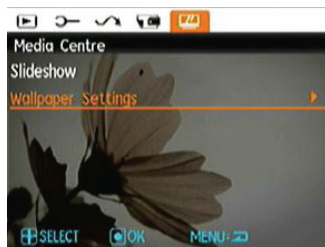



3. Press the func_{ok} button to confirm setting.

Playing Effect (Only for J1455)

You can use this setting to select the effect of playing photo.

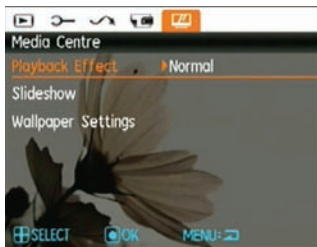
1. Select Playing Effect menu, press Right button, and camera will enter the setting screen of Playing Effect.



2. Press Up/Down button to select Natural or Vivid, and press  button to confirm the setting.

3. When Vivid is selected for Playing Effect, please enter the Playback mode, slid the zoom lever to the side , and the following displaying effect will appear:

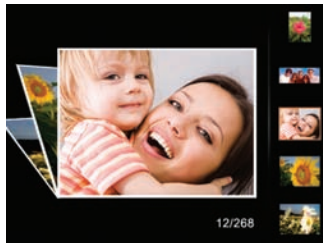

Setup Menu

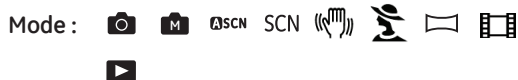

The Setup menu for the camera is available in all modes. Each menu page can be selected by pressing the menu button and switching between menus with the Left/Right button.

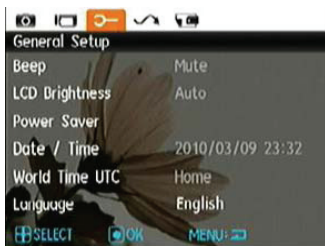

To adjust the settings:

1. Select the menu page with the function you want to adjust and press the Down button.

2. Switch between different functions with the Up/Down button.
3. Press the Right button to enter the submenu.



After selecting a function option, you can press the Up button to return to the menu for other Camera Setup pages. Or you can press the Down button to switch to the next menu page.

Refer to the following pages for more details about each setting.

Beep

Use this setting to adjust the volume of beep when buttons are pressed and change the tones for Shutter button, self-timer, and power-on/power-off.

To change this setting:

1. Select the **Beep** setting from the **Setup** menu as described previously.
2. Use the **Up/Down** navigation buttons to switch between volume, shutter tone, key tone, self-timer tone, and power tone fields.

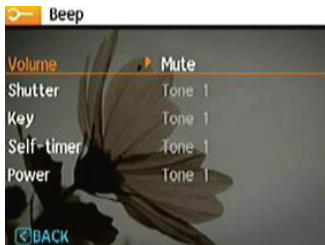

3. Press the Right button, press the Up/Down button to adjust volume and change tone, and press the **func**/**ok** button to confirm setting.

LCD Brightness

Use this setting to adjust the brightness of your LCD screen.

1. Select the **LCD Brightness** setting from the **Setup** menu as described previously.
2. Select auto or adjust the brightness level using the Left/Right button, and press the **func**/**ok** button to confirm the setting.

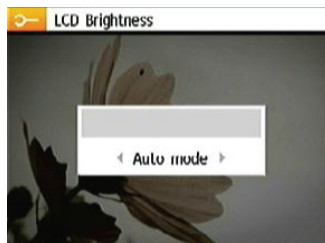

Power Saver

This setting allows you to save power and get the maximum possible running time for your battery. Follow the steps below to turn off the LCD screen and camera automatically after a period of inactivity.

1. Select the **Power Saver** setting from the **Setup** menu as described previously.
2. Press the Up/Down button to select the power items for the screen and camera and press the Right button.

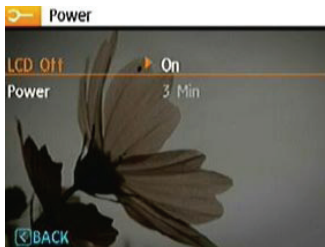



3. Press the Up/Down button to adjust the selected item. Both items have the following options:

- Turn off the LCD:
30 sec, 1 min, 2 min, and off.
 - Turn off the camera:
3 min, 5 min, 10 min, and off.
4. Press the func_{ok} button to confirm.

Zone

The Zone setting is a useful function on your overseas trips. This feature enables you to display the local time on the LCD screen while you are overseas.

1. Select the **Zone** setting from the **Setup** menu as described previously. The world time screen appears.
2. Use the **Up/Down** navigation buttons to switch between the hometown () and travel destination () fields.
3. Use the **Left/Right** navigation buttons to select a city close to the desired time zone. Then press the func_{ok} button to confirm.



Date/Time

See "Setting the Date and Time" section on page 19.

Language

See "Setting the Language" section on page 20.

File and Software

Format Memory

Please note: formatting enables you to delete all contents in the memory card and built-in memory, including protected photo and movie files.

To use this setting:

1. Select the Format in File and Software menu.
2. Use the Left/Right navigation buttons to select Yes or No, and press the ^{func}ok button to confirm.

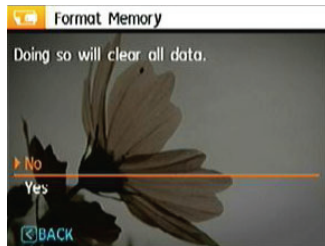

3. The current media is formatted.

File Numbering

After you take a picture or video clip, the camera will save it as file that ends with a serial number. You can use this item to choose whether the file is serially numbered or begins with 1 and is saved in another folder on the memory card.

1. Select the File Name in File and Software menu.
2. Select the option with the Up/Down button and press the **func**
ok button for confirmation.

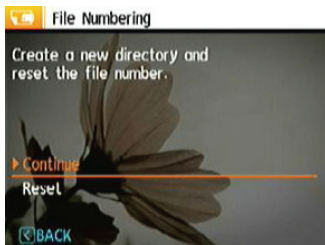

Copy to Card (Copy internal memory to memory card)

Use this setting to copy the files stored in the internal memory to the memory card.

1. Select the **Copy to memory card** in File and Software menu.
2. Use the **Up/Down** navigation buttons to select **Yes** or **No**. Then press the **func**
ok button to confirm.

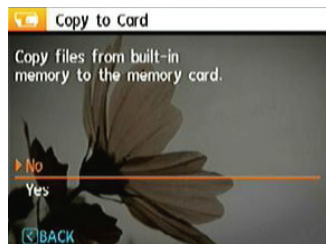

Reset Settings

Use this setting to restore the camera to its default settings.

1. Select the **Reset** setting in File and Software menu.
2. Use the **Up/Down** navigation buttons to select **Yes** or **No**. Then press the func / ok button to confirm.



FW Version (Firmware Version)

Use this setting to view the current camera firmware version.

1. Select the **FW Version** in File and Software menu.
2. If SD card contains a new version of firmware, please upgrade accordingly as necessary.



To update to the latest firmware version, you can go to the following website: www.ge.com/digitalcameras and look under Support.

Video System

Use this setting to determine your video system in the current area.

1. Select the **Video System** in **Connection Setup** menu.
2. Use the **Up/Down** navigation buttons to select **NTSC** or **PAL**. Then press the **runC** button to confirm.

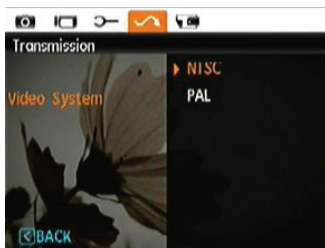

The video output signal can be switched to NTSC or PAL to accommodate different regional standards. The appropriate setting will vary between regions.

NTSC: USA, Canada, Taiwan, Japan, etc.

PAL: Europe, Asia (excluding Taiwan), Oceania, etc.

Note: The TV output will not display properly if an incorrect video system is selected.

Connecting to a PC

Use the USB cable and ArcSoft software (CD-ROM) supplied with your camera to copy (transfer) pictures to a computer.

Setting the USB mode

Since the camera's USB port can be set to connect with either a PC or a Printer, the following steps will allow you to ensure that the camera is correctly configured to connect with a PC.

1. Press the **func** button and use the **Up/Down** navigation buttons to select **USB Connect**, and then press the **Right** navigation button.
2. Use the **Up/Down** navigation buttons to select **PC**.
3. Press the **func** button to confirm the setting.

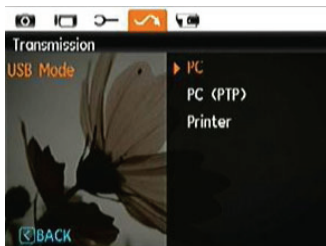

Transferring files to your PC

The computer will automatically detect the camera as a removable drive. Double-click **My Computer** icon on the desktop to locate the removable drive and to copy the folders and files in the drive to a directory on your PC as you would copy any typical folder or file.

By using the USB cable, you can transfer the captured photos and videos to a PC. Follow the steps below to connect the camera to a PC.

1. Start a computer to which ArcSoft software has been installed.
2. Make sure both the camera and PC are turned on.
3. Connect one end of the supplied USB cable to the USB/AV OUT port on your camera.
4. Connect the other end of the cable to an available USB port on your PC.

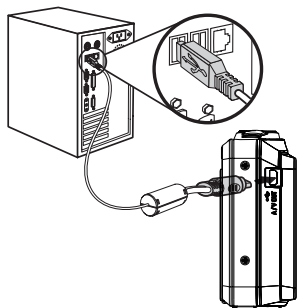

5. Disconnect the camera once transfer is completed.

If the USB option is set to [PC] :

Turn the camera off and disconnect the USB cable.

If the USB option is set to [PC (PTP)] :

Remove the camera from the system as described below before turning the camera off and disconnecting the USB cable.

Windows operating system (Windows 2000, Windows XP, Windows Vista, Windows 7.)

Click the [Safely remove the hardware] icon and remove the USB connector according to the appeared menu.



Macintosh

Drag the untitled icon to the Trash. ("Untitled")



Connecting to a PictBridge Compatible Printer



PictBridge allows printing images from a memory card in a digital camera directly to a printer, regardless of brand. To find out if a printer is PictBridge compatible, simply look for the PictBridge logo on the packaging or check

the manual for specifications. With the PictBridge function on your camera, you can print the captured photos directly with a PictBridge compatible printer using the supplied USB cable, without the need for a PC.

Setting the USB mode

Since the camera's USB port can be set to connect with either a PC or a Printer, the following steps will allow you to ensure that the camera is correctly configured to connect with a Printer.

1. Go to the camera setting menu, select USB connection with the Up/Down button, and press the Right button.
2. Use Up/Down to select Printer.

3. Press the **func**/**ok** button to confirm the setting.

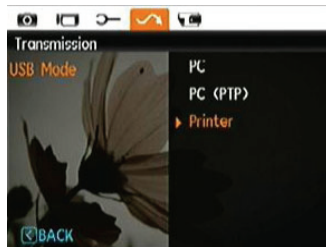

After the camera is reset, it will switch to PC mode automatically from USB mode.

Connecting the camera and printer.

1. Make sure both the camera and printer are turned on.
2. Connect one end of the supplied USB cable to the USB port on your camera.
3. Connect the other end of the cable to the USB port on the printer.

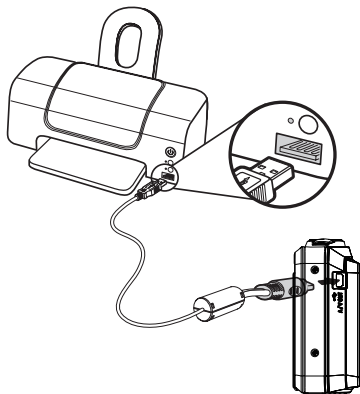

If the camera is not connected to a PictBridge compatible printer, the following error message appears on the LCD screen.

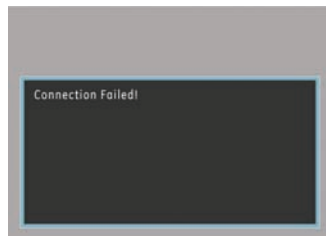

-  The above error message would also appear if the USB mode were set incorrectly, in which case you should disconnect the USB cable, check the USB mode settings, ensure that the Printer is turned on, and then try connecting the USB cable again.

Using the PictBridge Menu

After setting the USB mode to Printer, the **PictBridge** menu appears.



Select a menu item with the Up/Down button and press the Right button or **func**/**ok** button to enter the item.

Refer to the following sections for more detailed information on each setting.

Print with date

If you have set the date and time of your camera, the date and time will be recorded and saved with each photo you take.

1. Select **Print with date** from the **PictBridge** menu. The following screen appears.

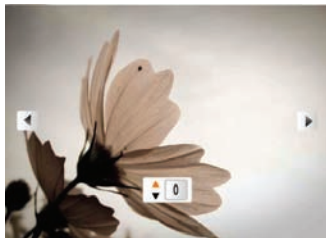

2. Use the **Left/Right** navigation buttons to scroll through the photos.

- Use the **Up/Down** navigation buttons to select the number of prints for the current displayed photo.
- Press the **func**/**ok** button and the following screen appears.



- Select **Yes** to confirm the printing, or **Cancel**. Then press the **func**/**ok** button.

Print without date

Use this setting to print the photos without dates on them.

- Select **Print without date** from the **PictBridge** menu. The following screen appears.



- Use the **Left/Right** navigation buttons to scroll through the images.
- Use the **Up/Down** navigation buttons to select the number of prints for the current displayed image.
- Press the **func**/**ok** button and the following screen appears.

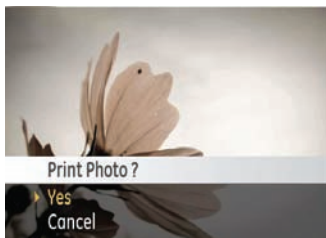

5. Select **Yes** to confirm the printing, or **Cancel**. Then press the **func**/**ok** button.

2. Select **Yes** to confirm the printing, or **Cancel**. Then press the **func**/**ok** button.

Print index

You can use this setting to print all indexes to show all the photos currently in your camera.

1. Select **Print index** from the **PictBridge** menu. The following screen appears.

Print DPOF (Digital Print Order Format)

To use DPOF printing, you must make the selection of photos for printing using the DPOF settings before hand. See “DPOF” section on page 57.

1. Select **Print DPOF** from the **PictBridge** menu. The following screen appears.

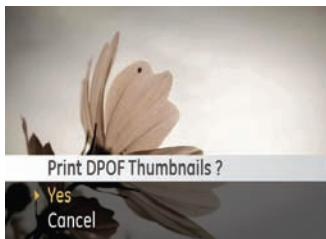

2. Select **Yes** to confirm the printing, or **Cancel**. Then press the **func**/**ok** button.

Exit

To exit the **PictBridge** menu, select **Exit**. The “Remove USB cable” message will be displayed.



Disconnect the USB cable from the camera and printer.

APPENDICES

Specifications : A1255 / A1455



Design and specifications are subject to change without notice.

Model name		A1255	A1455
Effective Image Sensor Pixels		12.2 Megapixels	14.1 Megapixels
Image Sensor		12.4 Megapixels [1/2.33" (CCD)]	14.2 Megapixels [1/2.3" (CCD)]
Lens	Focal Length F =	6.3mm (Wide) ~ 31.5mm (Tele)	
	35mm film equivalent	35mm (Wide) ~ 175mm (Tele)	
	F number	F3.0 (Wide) ~ F4.7 (Tele)	
	Construction	9 elements in 7 groups	
	Optical Zoom	5X	
	Focusing Range	Normal: (Wide) 60cm ~ ∞, (Tele) 80cm ~ ∞; Macro: (Wide) 5cm ~ 80cm, (Tele) 60cm ~ ∞	
Anti-Handshake		Electronic Image Stabilization	
Digital Zoom		5.7X digital zoom (Combined Zoom: 28.5X)	

Model name		A1255	A1455
Number of Recording Pixels	Still Image	12MP, 10MP(3:2), 9MP(16:9), 8MP, 5MP, 3MP, 0.3MP	14MP, 12MP(3:2), 10MP(16:9), 8MP, 5MP, 3MP, 0.3MP
	Movie	640x480pixels: 30fps/15fps, 320x240pixels: 30fps/15fps	
Image Compression		Best, Fine, Normal	
DCF, DPOF (Ver1.1) Support		Yes	
File Format	Still Image	Exif 2.2 (JPEG)	
	Movie	Quick Time Motion JPEG, Audio: G.711 [Monaural]]	
Shooting Modes		Auto, Manual, Auto-Scene, Scene (Sport, Indoor, Snow, Fireworks, Museum, Night Landscape, Children, Leaf, Sunset, Glass, Landscape, Night Portrait), Stabilization, Portrait, Panorama, Video	
Smile Detection		Yes	
Blink Detection		Yes	
Face-Detection		Yes	
Red-eye Removal		Yes	

Model name	A1255	A1455
Pan-Capture Panorama	Yes	
LCD Display	2.7 inch (230,400 pixels) LTPS (low-temperature polycrystalline silicon) TFT color LCD	
ISO Sensitivity	Auto, ISO80/100/200/400/800/1600	
AF Method	Single AF, Multi-AF (TTL 9-point), AF Assist Light (On/Off)	
Light Metering Method	Artificial Intelligence AE (AiAE), Center-weighted Average, Spot (Fixed to center of frame)	
Exposure Control Method	ProgramAE (AE-lock available)	
Exposure Compensation	±2 EV in 1/3 Step increments	
Shutter Speed	4 ~ 1/2000 second (Manual 30 s)	
Continuous Shooting	Approx. 1.8 fps (Large/Fine mode)	Approx. 1.39 fps (Large/Fine mode)
Playback Modes	Single Photo, Index (4/9/16 thumbnails), Slide Show, Movie (Slow-Motion possible), Zoom (Approx. 2X~8X), Audio, Histogram Display	
White Balance Control	Auto (AWB), Daylight, Cloudy, Fluorescent , Fluorescent CWF, Incandescent, Manual	

Model name	A1255	A1455
Internal Flash (Shooting Range)	Auto/Red-Eye Reduction/Forced Flash/No Flash/Slow Synchro/Red-Eye Reduction+Slow Synchro	
	Gno. 5.0 EV (ISO 100)	
	Shooting Range Wide: Approx. 0.6m~4.9m / Tele: Approx. 0.8m ~ 3.1m (ISO 800)	Shooting Range Wide: Approx. 0.6m~4.7m / Tele: Approx. 0.8m ~ 3.0m (ISO 800)
Recording Media	Internal Memory: 18MB	
	SD Card/SDHC Card (Up to 16GB support)	
Other Features	PictBridge, ExifPrint Support, Multi-language Support	
Jacks	USB2.0/AV-OUT (Integrated Proprietary Connector)	
Power	2 x AA Alkaline Battery, AA NiMH Battery [Not Included]	
Shooting Capability (Battery Performance)	AA Alkaline Batteries: Approx. 120 shots (based on CIPA standards)	AA Alkaline Batteries: Approx. 150 shots (based on CIPA standards)
	AA NiMH Battery : Approx. 360 shots (CIPA Standards)	AA NiMH Battery : Approx. 340 shots (CIPA Standards)
Operation Environment	Temperature: 0~40°C, Humidity: 0~90%	
Dimensions (W x H x D)	93mm x 61mm x (24.1~27.1) mm	
Mass	Approx. 130g (Body only)	Approx. 140g (Body only)

Specifications : J1455



Design and specifications are subject to change without notice.

Effective Image Sensor Pixels		14.1 Megapixels
Image Sensor		14.2 Megapixels [1/2.3" (CCD)]
Lens	Focal Length F =	6.3mm (Wide) ~ 31.5mm (Tele)
	35mm film equivalent	35mm (Wide) ~ 175mm (Tele)
	F number	F3.0 (Wide) ~ F4.7 (Tele)
	Construction	9 elements in 7 groups
	Optical Zoom	5X
	Focusing Range	Normal: (Wide) 60cm ~ ∞, (Tele) 80cm ~ ∞; Macro: (Wide) 5cm ~ 80cm, (Tele) 60cm ~ ∞
Anti-Handshake		Electronic Image Stabilization
Digital Zoom		5.7X digital zoom (Combined Zoom: 28.5X)

Number of Recording Pixels	Still Image	14MP, 12MP(3:2), 10MP(16:9), 8MP, 5MP, 3MP, 0.3MP
	Movie	640x480pixels: 30fps/15fps, 320x240pixels: 30fps/15fps
Image Compression		Best, Fine, Normal
DCF, DPOF (Ver1.1) Support		Yes
File Format	Still Image	Exif 2.2 (JPEG)
	Movie	Quick Time Motion JPEG, Audio: G.711 [Monaural])
Shooting Modes		Auto, Manual, Auto-Scene, Scene (Sport, Indoor, Snow, Fireworks, Museum, Night Landscape, Children, Leaf, Sunset, Glass, Landscape, Night Portrait), Stabilization, Portrait, Panorama, Video
Smile Detection		Yes
Blink Detection		Yes
Face-Detection		Yes
Red-eye Removal		Yes

Pan-Capture Panorama	Yes
LCD Display	3.0 inch (230,400 pixels) LTPS (low-temperature polycrystalline silicon) TFT color LCD
ISO Sensitivity	Auto, ISO 80/100/200/400/800/1600
AF Method	Single AF, Multi-AF (TTL 9-point), AF Assist Light (On/Off)
Light Metering Method	Artificial Intelligence AE (AiAE), Center-weighted Average, Spot (Fixed to center of frame)
Exposure Control Method	ProgramAE (AE-lock available)
Exposure Compensation	±2 EV in 1/3 Step increments
Shutter Speed	4 ~ 1/2000 second (Manual 30 s)
Continuous Shooting	Approx. 1.39 fps (Large/Fine mode)
Playback Modes	Single Photo, Index (4/9/16 thumbnails), Slide Show, Movie (Slow-Motion possible), Zoom (Approx. 2X~8X), Audio, Histogram Display
White Balance Control	Auto (AWB), Daylight, Cloudy, Fluorescent , Fluorescent CWF, Incandescent, Manual

Internal Flash (Shooting Range)	Auto/Red-Eye Reduction/Forced Flash/No Flash/Slow Synchro/Red-Eye Reduction+Slow Synchro
	Gno. 5.0 EV (ISO 100)
	Shooting Range Wide: Approx. 0.6m~4.7m / Tele: Approx. 0.8m ~ 3.0m (ISO 800)
Recording Media	Internal Memory: 18MB
	SD Card/SDHC Card (Up to 16GB support)
Other Features	PictBridge, ExifPrint Support, Multi-language Support
Jacks	USB2.0/AV-OUT (Integrated Proprietary Connector)
Power	Rechargeable Lithium-ion Battery GB-10 (D016), 3.7V 700mAh
Shooting Capability (Battery Performance)	Approx. 180 shots (based on CIPA Standards)
Operation Environment	Temperature: 0~40 ^o C, Humidity: 0~90%
Dimensions (W x H x D)	96.4mm x 61mm x (20.5~22.5) mm
Mass	Approx. 138g (Body only)

Error messages

Messages	Explanation
No card	<ul style="list-style-type: none">• The memory card is not inserted.
Card error	<ul style="list-style-type: none">• The memory card is not formatted.
Card full	<ul style="list-style-type: none">• The memory card is full and cannot store any new images.
Write protect	<ul style="list-style-type: none">• The memory card is write-protected.
Picture error	<ul style="list-style-type: none">• The picture is not captured correctly.• The picture is damaged.
No picture	<ul style="list-style-type: none">• There are no images in the memory card or in the internal memory.
Lens error	<ul style="list-style-type: none">• The lens is probably stuck and the camera will power off automatically.
System error	<ul style="list-style-type: none">• Unexpected error encountered.
Image cannot be saved	<ul style="list-style-type: none">• The write protection switch in the memory card is set to the "LOCK" position.
Out of the range	<ul style="list-style-type: none">• When pictures were taken in Panorama mode, the direction of movement was incorrect or the angle was outside the range of the internal settings.
The maximum specified water depth was exceeded	<ul style="list-style-type: none">• During underwater recording or shooting, the camera was taken deeper than the maximum allowable depth.

Messages	Explanation
When the camera is used for longer than the specified time it may be damaged.	<ul style="list-style-type: none"> • During underwater recording or shooting, the camera was kept under water longer than the specified time.
Card is not formatted, format?	<ul style="list-style-type: none"> • Confirm whether the memory card should be formatted.
This image cannot be deleted	<ul style="list-style-type: none"> • The picture or video you are trying to delete is protected.
Cannot record movie	<ul style="list-style-type: none"> • The write protection switch in the memory card is set to the "LOCK" position.
Warning!! Camera recording, please wait.	<ul style="list-style-type: none"> • No other actions allowed to perform during video/audio recording.
Warning!! Battery exhausted.	<ul style="list-style-type: none"> • The battery is out of charge.
This file cannot be played back	<ul style="list-style-type: none"> • The picture format cannot be recognized by the camera.
No connection	<ul style="list-style-type: none"> • The camera is not connected to the printer correctly.
Print error	<ul style="list-style-type: none"> • There is a problem with camera or printer.
Cannot print	<ul style="list-style-type: none"> • Check that the printer is out of paper or out of ink. • Check if the printer has a paper jam.

Troubleshooting

Problem	Possible causes	Solution
Camera does not turn on.	<ul style="list-style-type: none">• The battery has run out.• The battery is not inserted correctly.	<ul style="list-style-type: none">• Replace with a fully charged battery.
Camera turns off suddenly during operation.	<ul style="list-style-type: none">• The battery has run out.	<ul style="list-style-type: none">• Replace with a fully charged battery.
The picture is blurred.	<ul style="list-style-type: none">• The lens is dirty.•  appears when taking pictures.	<ul style="list-style-type: none">• Use a soft cloth to clean the lens on your camera• Use the Image Stabilization mode.
Images and video files cannot be saved.	<ul style="list-style-type: none">• The memory card is full.	<ul style="list-style-type: none">• Replace the memory card with a new one.• Delete unwanted images.• Unlock the memory card.

Problem	Possible causes	Solution
No picture is taken when pressing the Shutter button.	<ul style="list-style-type: none"> • The memory card is full. • No available space to store the files. • The mode dial is in Playback mode. 	<ul style="list-style-type: none"> • Replace the memory card with a new one or clean off current memory card. • Delete unwanted images. • The memory card is locked.
Images cannot print from the connected printer.	<ul style="list-style-type: none"> • The camera is not connected to the printer correctly. • The printer is not PictBridge compatible. • The printer is out of paper or out of ink. • The paper is jammed. 	<ul style="list-style-type: none"> • Check the connection between the camera and printer. • Use a PictBridge compatible printer. • Load some paper in the printer. • Replace the ink cartridge in the printer. • Remove the jammed paper.

<http://www.ge.com/digitalcameras>

